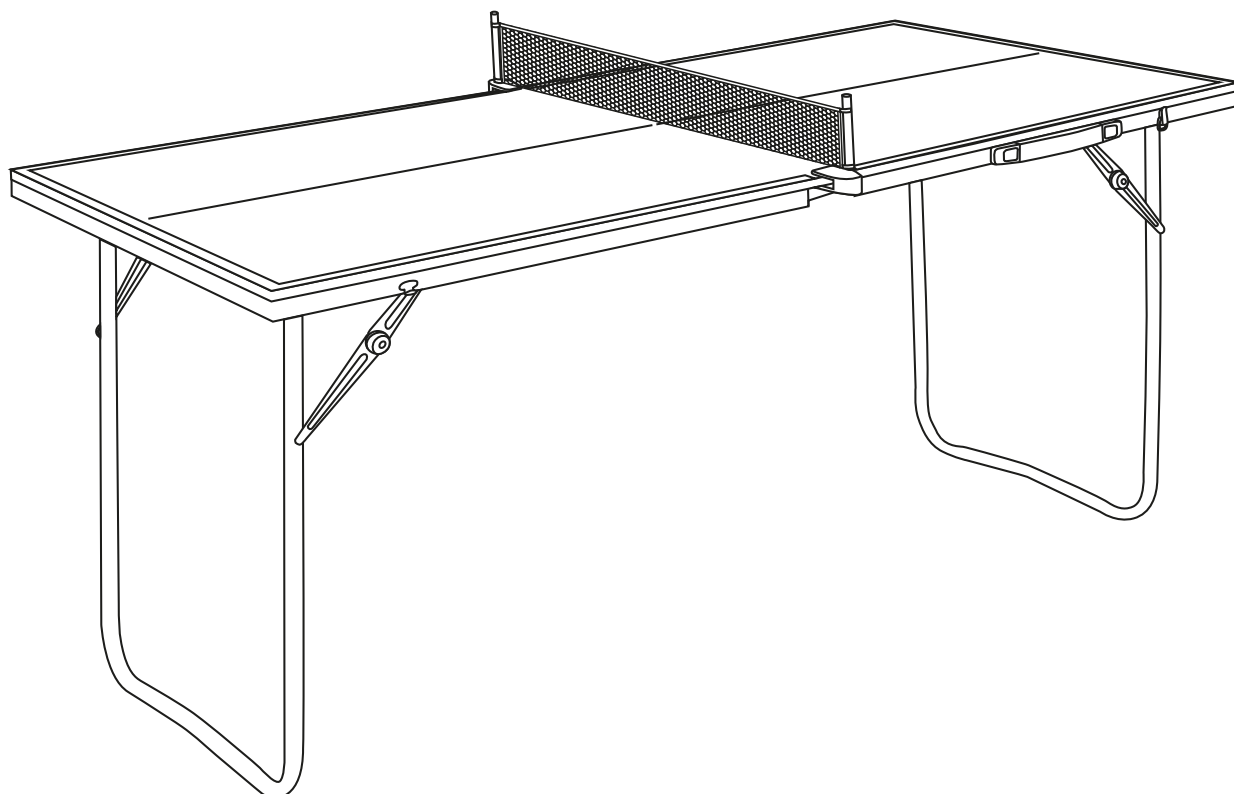

Table tennis table / Tischtennisplatte / Tafel Tennistafel /
Table de tennis de table / Mesa de ping-pong / Tavolo da ping pong



TABLE TENNIS TABLE MINI 1500 BASIC



Instruction Manual
Gebrauchsanweisung
Gebruikshandleiding
Mode D'emploi
Manual De Usuario
Istruzione Per L'uso

TABLE TENNIS TABLE MINI 1500 BASIC



! NOTICE



EN

WARNING

CHOKING HAZARD

Small parts. Not suitable for children under 36 months.

THE PRODUCT IS TO BE ASSEMBLED BY AN ADULT.

Potential hazard description, e.g. In unassembled state contain potentially hazardous sharp points, so please keep out of baby's reach.

Only for domestic use. Retain for future reference.

DE

WARNUNG

VERSCHLUCKUNGSGEFAHR

Kleine Teile. Für Kinder unter 3 Jahren nicht geeignet.

DAS PRODUKT IST VON EINEM ERWACHSENEN ZUSAMMENGEBAUT WERDEN.

Beschreibung potenzieller Gefahr, z.B. in nicht zusammengesetztem Zustand enthält es potenziell gefährliche scharfe Spitzen, daher von Babys fernhalten!

Nur für den häuslichen Gebrauch. Diese Informationen aufheben.

NL

WAARSCHUWING

VERSTIKKINGSGEVAAR

Kleine onderdelen. Niet geschikt voor kinderen onder de 36 maanden.

HET PRODUCT MOET DOOR EEN VOLWASSENE GEMONTEERD WORDEN.

Beschrijving potentieel gevaar, bv in ongemonteerde toestand bevat het potentieel gevaarlijke punten, zorg ervoor dat baby's er niet bij kunnen.

Alleen geschikt voor particulier gebruik. Bewaar deze informatie.

FR

AVERTISSEMENT

RISQUE D'ÉTOUFFEMENT

Petit matériel. Ne convient pas pour les enfants de moins de 36 mois.

LE PRODUIT DOIT ÊTRE ASSEMBLÉ PAR UN ADULTE.

Description de risque potentiel, par exemple, Démonté, contient des pointes potentiellement dangereuses. À conserver hors de portée des enfants en bas âge.

Convient uniquement pour l'utilisation. Conserver pour une consultation ultérieure.

ES

ADVERTENCIA

PELIGRO DE ASFIXIA

Piezas pequeñas. No adecuado para menores de 36 meses.

EL PRODUCTO DEBE SER MONTADO POR UN ADULTO

Descripción de posible peligro, p. ej.: El producto desmontado contiene posibles puntos afilados, así que debe mantenerse fuera del alcance del bebé

Sólo para uso doméstico. Conservar para futuras consultas.

IT

AVVERTENZA

PERICOLO DI SOFFOCAMENTO

Componenti di piccole dimensioni. Non adatto per bambini di età inferiore a 36 mesi.

IL GIOCATTOLO DEVE ESSERE MONTATO DA UN ADULTO.

Descrizione dei rischi potenziali, ad es. in condizioni smontate contiene parti acuminate potenzialmente pericolose; tenere quindi fuori dalla portata del bambino.

Esclusivamente per uso domestico. Conservare per riferimento futuro.

TABLE TENNIS TABLE MINI 1500 BASIC

ASSEMBLY



1

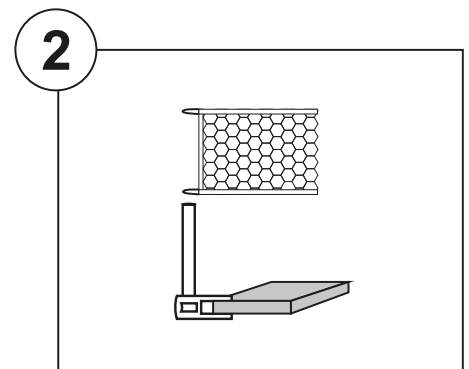
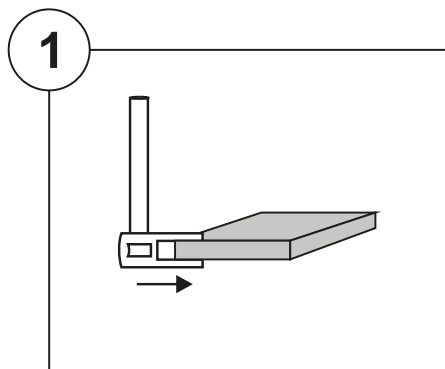
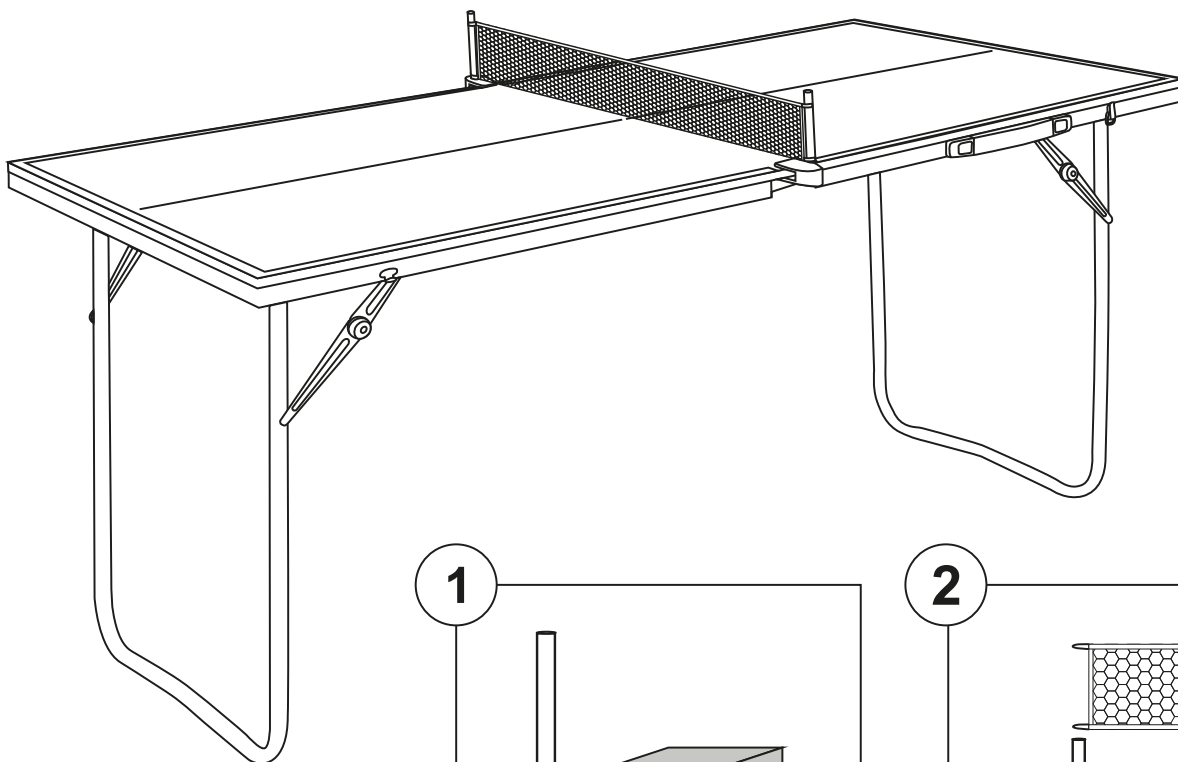
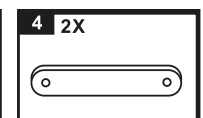
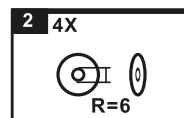
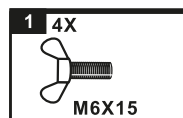
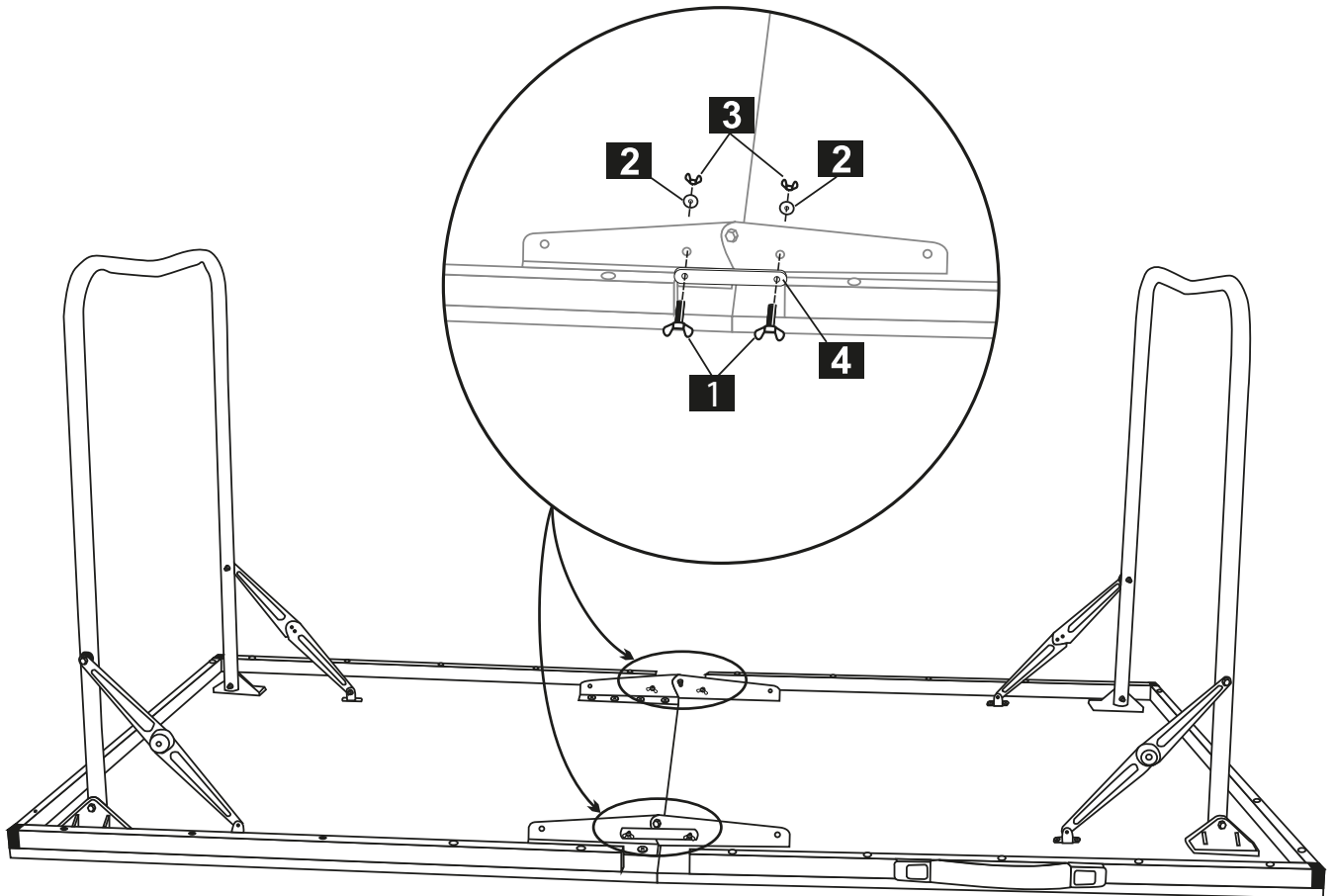

TABLE TENNIS TABLE MINI 1500 BASIC

ASSEMBLY



2





Indoor
use only

SAFETY



Attention: Any person handling or using this table must follow the instructions opposite and read this notice

The person in charge of assembling and using this table must ensure that the recommendations for use given in this notice are seen by all users. In communal use, it is strongly recommended that the instructions and diagrams are displayed

Only use this table after it has been fully assembled and after checking that the safety systems are working properly.

Users must report any defects and faults in the safety systems, and Immediately replace faulty parts and not use the table until it has been fully repaired.



Assembly, positioning and storage must be carried out by an adult or under the direct supervision and responsibility of an adult. Do not leave children unattended around the table. By their very nature, children love playing and if they use the table tennis table for other purposes, they may put themselves in danger or unforeseeable situations. The manufacturer will not be liable for any injury caused through misuse of the table.



NON-COMPLIANCE WITH THE ABOVE INSTRUCTIONS FOR USE MAY RESULT IN DAMAGE TO THE TABLE OR INJURY AND EXCLUDES ANY LIABILITY OF THE MANUFACTURER. THE MANUFACTURER MAKE CONSTANT IMPROVEMENTS TO THE PRODUCT, RESERVES THE RIGHT TO MAKE TECHNICAL AND DIMENSIONAL MODIFICATIONS WITHOUT THESE INSTRUCTIONS BEING BINDING ON US.

USE & STORAGE

DO NOT store this table outdoors. Outdoor conditions will damage this table. Even with a cover, INDOOR tables will be damaged if used outside.



Do not leave children unattended around the table.

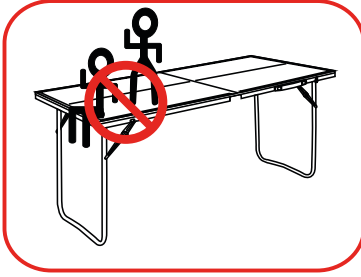

Do not sit or stand on the table, because of the risk of collapse.

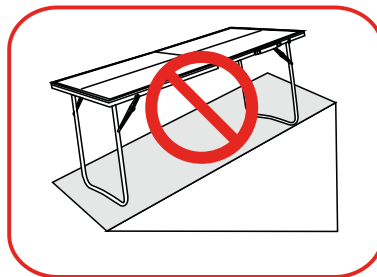

Do not use on a slope.



OPEN

A

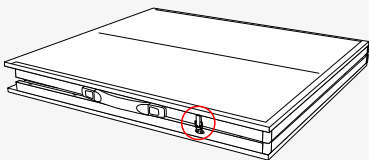

B

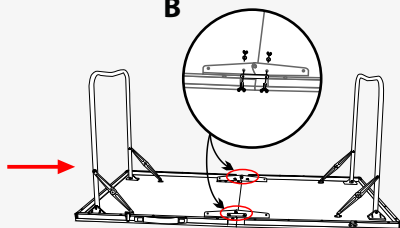

C

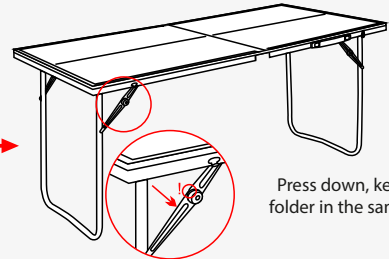

Press down, keep the folder in the same level

CLOSE

A

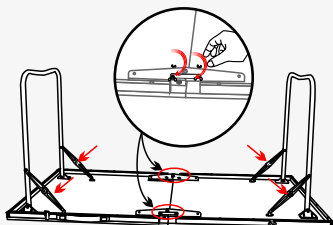

B



C

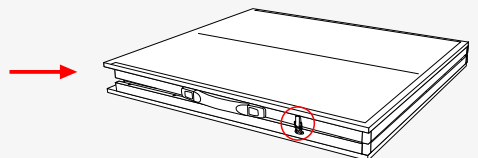



Innenbe-
reich

SICHERHEIT



Achtung! Jede Person, die mit diesem Tisch umgeht oder ihn benutzt, muss die nebenstehenden Anweisungen befolgen und diesen Hinweis lesen.

Die Person, die für den Aufbau und die Benutzung des Tisches verantwortlich ist, muss sicherstellen, dass die in dieser Anleitung enthaltenen Empfehlungen für alle Benutzer sichtbar sind. Bei gemeinschaftlicher Nutzung wird dringend empfohlen, die Anweisungen und Diagramme auszuhängen.

Benutzen Sie den Tisch erst, nachdem er vollständig zusammengebaut wurde und nachdem Sie sich vom einwandfreien Funktionieren der Sicherheitssysteme überzeugt haben.

Die Benutzer müssen alle Mängel und Fehler an den Sicherheitssystemen melden, defekte Teile sofort austauschen und den Tisch bis zur vollständigen Reparatur nicht benutzen.



Der Aufbau, die Aufstellung und die Lagerung müssen von einem Erwachsenen oder unter dessen direkter Aufsicht und Verantwortung durchgeführt werden. Lassen Sie Kinder nicht unbeaufsichtigt in der Nähe des Tisches. Es liegt in der Natur der Sache, dass Kinder gerne spielen, und wenn sie den Tischtennistisch für andere Zwecke verwenden, können sie sich selbst in Gefahr bringen oder in unvorhersehbare Situationen geraten. Der Hersteller haftet nicht für Verletzungen, die durch unsachgemäßen Gebrauch des Tisches entstehen.



DIE NICHTBEACHTUNG DER OBEN GENANNTEN GEBRAUCHSANWEISUNGEN KANN ZU SCHÄDEN AM TISCH ODER ZU VERLETZUNGEN FÜHREN UND SCHLIESST JEGLICHE HAFTUNG DES HERSTELLERS AUS. DER HERSTELLER VERBESSERT DAS PRODUKT STÄNDIG UND BEHÄLT SICH DAS RECHT VOR, TECHNISCHE UND MASSLICHE ÄNDERUNGEN VORZUNEHMEN, OHNE DASS DIESE ANWEISUNGEN FÜR UNS VERBINDLICH SIND.

VERWENDUNG UND LAGERUNG

Lagern Sie diesen Tisch nicht im Freien. Die Außenbedingungen beschädigen diesen Tisch. Selbst mit einer Abdeckung werden INDOOR-Tische beschädigt, wenn sie im Freien verwendet werden.



Lassen Sie Ihre Kinder nicht unbeaufsichtigt am Tisch sitzen.

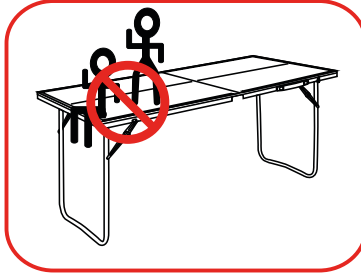

Setzen oder stellen Sie sich nicht auf den Tisch, da die Gefahr eines Zusammenbruchs besteht.



Nicht an einem Hang verwenden.



ÖFFNEN SIE

A

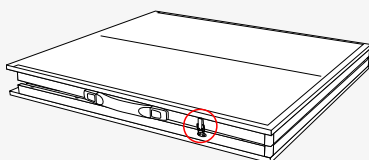

B

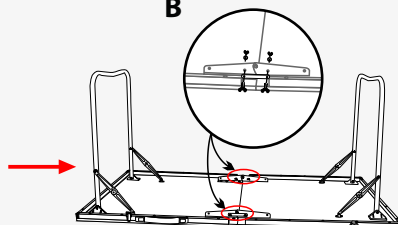

C

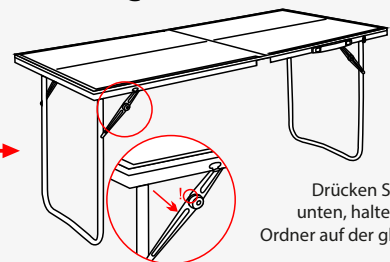

SCHLIESSEN SIE

A

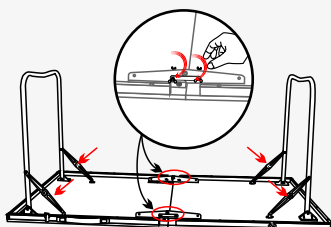

B



C

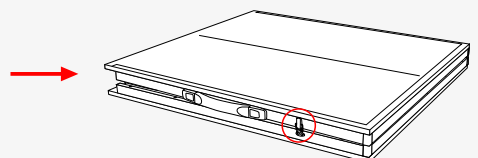



Alleen
voor
binnen

BEVEILIGING



Attentie: Iedereen die deze tafel hanteert of gebruikt, moet de instructies hiernaast opvolgen en deze gebruiksaanwijzing lezen.

De persoon die verantwoordelijk is voor de montage en het gebruik van deze tafel moet ervoor zorgen dat de aanbevelingen voor gebruik in deze gebruiksaanwijzing door alle gebruikers worden gezien. Bij gemeenschappelijk gebruik is het sterk aanbevolen de instructies en schema's op te hangen.

Gebruik deze tafel alleen nadat hij volledig is gemonteerd en nadat u hebt gecontroleerd of de veiligheidssystemen goed werken.

Gebruikers moeten alle defecten en storingen in de veiligheidssystemen melden en defecte onderdelen onmiddellijk vervangen en de tafel niet gebruiken totdat deze volledig is gerepareerd.



Montage, plaatsing en opslag moeten worden uitgevoerd door een volwassene of onder direct toezicht en verantwoordelijkheid van een volwassene. Laat kinderen niet zonder toezicht rond de tafel. Kinderen spelen van nature graag en als ze de tafeltennistafel voor andere doeleinden gebruiken, kunnen ze zichzelf in gevaar brengen of in onvoorziene situaties terechtkomen. De fabrikant is niet aansprakelijk voor letsel dat ontstaat door verkeerd gebruik van de tafel.



HET NIET NALEVEN VAN DE BOVENSTAANDE GEBRUIKSINSTRUCTIES KAN LEIDEN TOT SCHADE AAN DE TAFEL OF LETSEL EN SLUIT ELKE AANSPRAKELIJKHEID VAN DE FABRIKANT UIT. DE FABRIKANT BRENGT VOORTDUREND VERBETERINGEN AAN HET PRODUCT AAN, BEHOUDT ZICH HET RECHT VOOR OM TECHNISCHE EN DIMENSIONALE WIJZIGINGEN AAN TE BRENGEN ZONDER DAT DEZE INSTRUCTIES BINDEND ZIJN VOOR ONS.

GEBRUIK EN OPSLAG

Bewaar deze tafel niet buitenshuis. Buitenomstandigheden beschadigen deze tafel. Zelfs met een hoes raken binnentafels beschadigd als ze buiten worden gebruikt.



Laat kinderen niet zonder toezicht rond de tafel zitten.

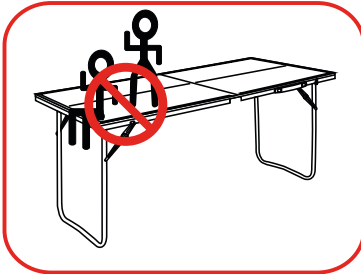

Ga niet op de tafel zitten of staan vanwege het risico op instorten.

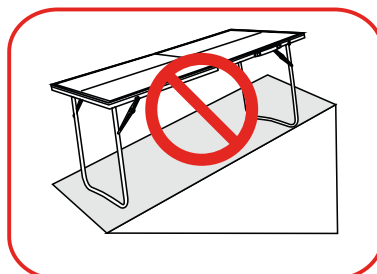

Niet gebruiken op een helling.



OPEN

A

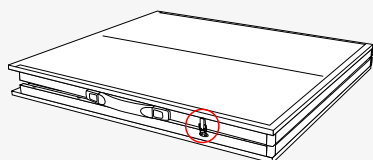

B

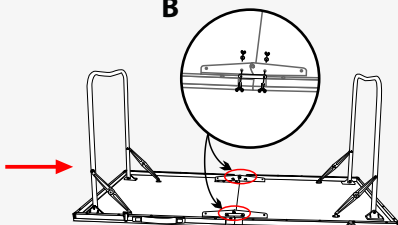

C

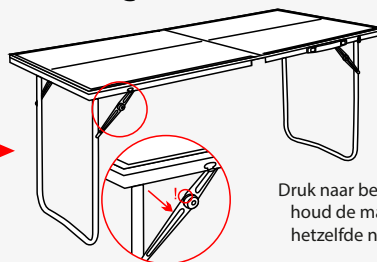

Druk naar beneden, houd de map op hetzelfde niveau

SLUIT

A

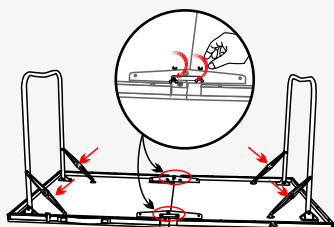

B

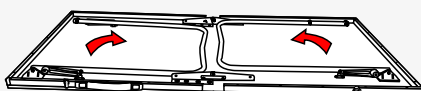

C

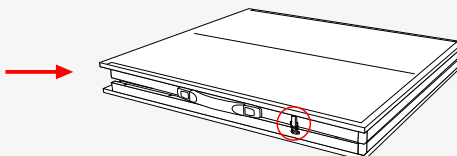



Intérieur

SÉCURITÉ



Attention : Toute personne manipulant ou utilisant cette table doit suivre les instructions ci-contre et lire cette notice

La personne chargée du montage et de l'utilisation de cette table doit s'assurer que les recommandations d'utilisation données dans cette notice sont vues par tous les utilisateurs. En cas d'utilisation en collectivité, il est fortement recommandé d'afficher les instructions et les schémas.

N'utilisez cette table qu'après l'avoir entièrement montée et après avoir vérifié le bon fonctionnement des systèmes de sécurité.

Les utilisateurs doivent signaler tout défaut et toute défaillance des systèmes de sécurité, remplacer immédiatement les pièces défectueuses et ne pas utiliser la table tant qu'elle n'a pas été entièrement réparée.



Le montage, la mise en place et le rangement doivent être effectués par un adulte ou sous la surveillance directe et la responsabilité d'un adulte. Ne laissez pas les enfants sans surveillance autour de la table. Par nature, les enfants aiment jouer et s'ils utilisent la table de tennis de table à d'autres fins, ils peuvent se mettre en danger ou dans des situations imprévisibles. Le fabricant n'est pas responsable des blessures causées par une mauvaise utilisation de la table.



LE NON-RESPECT DES INSTRUCTIONS D'UTILISATION CI-DESSUS PEUT ENTRAÎNER DES DOMMAGES À LA TABLE OU DES BLESSURES ET EXCLUT TOUTE RESPONSABILITÉ DU FABRICANT. LE FABRICANT APORTE DES AMÉLIORATIONS CONSTANTES AU PRODUIT, SE RÉSERVE LE DROIT D'APPORTER DES MODIFICATIONS TECHNIQUES ET DIMENSIONNELLES SANS QUE CES INSTRUCTIONS SOIENT CONTRAIGNANTES POUR NOUS.

UTILISATION ET STOCKAGE

Ne rangez pas cette table à l'extérieur. Les conditions extérieures endommageront cette table. Même avec une housse, les tables INDOOR seront endommagées si elles sont utilisées à l'extérieur.



Ne laissez pas les enfants sans surveillance autour de la table.

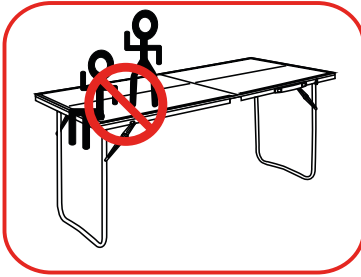

Ne pas s'asseoir ou se tenir debout sur la table, en raison du risque d'effondrement.



Ne pas utiliser sur une pente.



OUVRIR

A

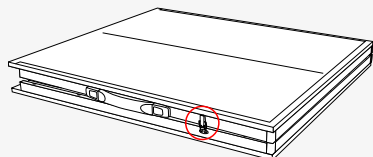

B

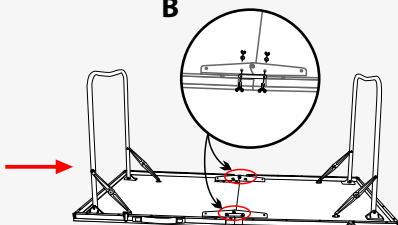

C

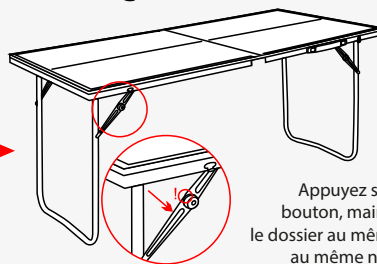

FERMER

A

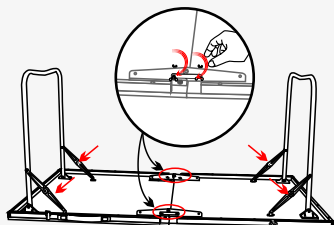

B

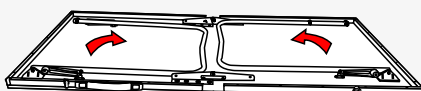

C

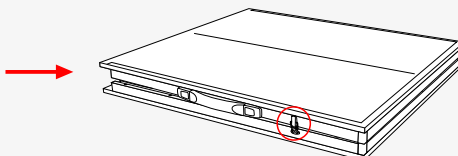



Interior

SEGURIDAD



Atención: Toda persona que manipule o utilice esta mesa debe seguir las instrucciones que figuran al lado y leer este aviso.

La persona encargada de montar y utilizar esta mesa debe asegurarse de que todos los usuarios vean las recomendaciones de uso que figuran en este aviso. En caso de uso colectivo, se recomienda encarecidamente que las instrucciones y los diagramas estén a la vista.

Utilice esta mesa sólo después de haberla montado completamente y de haber comprobado el buen funcionamiento de los sistemas de seguridad.

Los usuarios deben informar de cualquier defecto o avería en los sistemas de seguridad, sustituir inmediatamente las piezas defectuosas y no utilizar la mesa hasta que esté totalmente reparada.



El montaje, la colocación y el almacenamiento deben ser realizados por un adulto o bajo la supervisión directa y la responsabilidad de un adulto. No deje a los niños solos alrededor de la mesa. Por su propia naturaleza, a los niños les encanta jugar y si utilizan la mesa de ping-pong para otros fines, pueden ponerse en peligro o en situaciones imprevisibles. El fabricante no se responsabiliza de los daños causados por el mal uso de la mesa.



EL INCUMPLIMIENTO DE ESTAS INSTRUCCIONES DE USO PUEDE PROVOCAR DAÑOS EN LA MESA O LESIONES Y EXCLUYE CUALQUIER RESPONSABILIDAD DEL FABRICANTE. EL FABRICANTE REALIZA CONSTANTES MEJORAS EN EL PRODUCTO, SE RESERVA EL DERECHO DE REALIZAR MODIFICACIONES TÉCNICAS Y DIMENSIONALES SIN QUE ESTAS INSTRUCCIONES SEAN VINCULANTES PARA NOSOTROS.

USO Y ALMACENAMIENTO

No guarde esta mesa al aire libre. Las condiciones exteriores dañarán esta mesa. Incluso con una cubierta, las mesas INDOOR se dañarán si se utilizan en el exterior.



No dejes a los niños solos en la mesa.

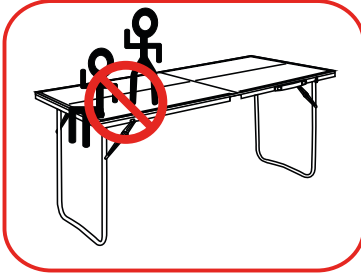

No se siente ni se ponga de pie sobre la mesa, por el riesgo de desplome.

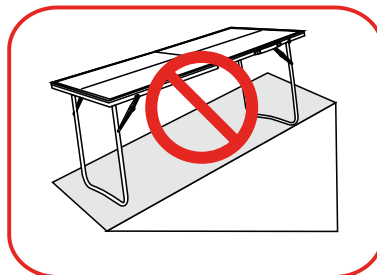

No utilizar en pendientes.



ABRIR

A

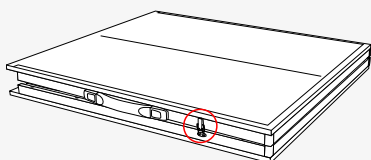

B

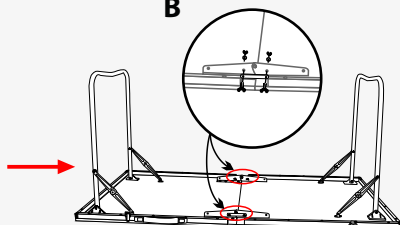

C

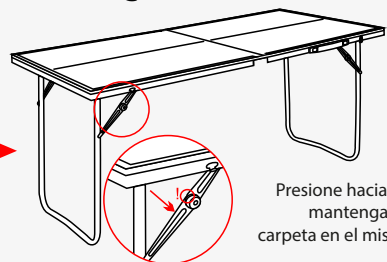

Presione hacia abajo, mantenga la carpeta en el mismo nivel

CERRAR

A

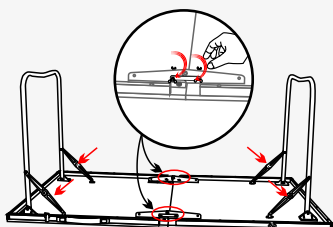

B



C

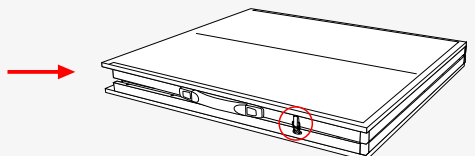



Interno

SICUREZZA



Attenzione: Chiunque manipoli o utilizzi questo tavolo deve attenersi alle istruzioni riportate a fianco e leggere il presente avviso.

La persona incaricata del montaggio e dell'uso di questo tavolo deve assicurarsi che le raccomandazioni d'uso riportate in questa nota siano visibili a tutti gli utenti. In caso di utilizzo in comune, si raccomanda vivamente di esporre le istruzioni e i diagrammi.

Utilizzare il tavolo solo dopo averlo montato completamente e dopo aver verificato il corretto funzionamento dei sistemi di sicurezza.

Gli utenti devono segnalare eventuali difetti e guasti dei sistemi di sicurezza e sostituire immediatamente le parti difettose e non utilizzare il tavolo finché non è stato completamente riparato.



Il montaggio, il posizionamento e lo stoccaggio devono essere eseguiti da un adulto o sotto la diretta supervisione e responsabilità di un adulto. Non lasciare i bambini incustoditi intorno al tavolo. Per loro natura, i bambini amano giocare e se utilizzano il tavolo da ping pong per altri scopi, possono mettersi in pericolo o in situazioni imprevedibili. Il produttore non è responsabile di eventuali lesioni causate da un uso improprio del tavolo.



L'INOSSERVANZA DELLE SUDETTE ISTRUZIONI D'USO PUÒ CAUSARE DANNI AL TAVOLO O LESIONI ED ESCLUDE QUALSIASI RESPONSABILITÀ DEL PRODUTTORE. IL PRODUTTORE APPORTA COSTANTI MIGLIORAMENTI AL PRODOTTO, SI RISERVA IL DIRITTO DI APPORTARE MODIFICHE TECNICHE E DIMENSIONALI SENZA CHE QUESTE ISTRUZIONI SIANO VINCOLANTI PER NOI.

USO E CONSERVAZIONE

Non conservare questo tavolo all'aperto. Le condizioni esterne danneggiano il tavolo. Anche con una copertura, i tavoli INDOOR si danneggiano se utilizzati all'esterno.



Non lasciate i bambini incustoditi a tavola.

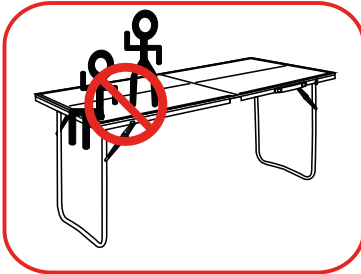

Non sedersi o stare in piedi sul tavolo, a causa del rischio di collasso.

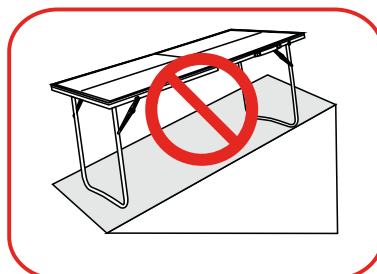

Non utilizzare in pendenza.



APERTO

A

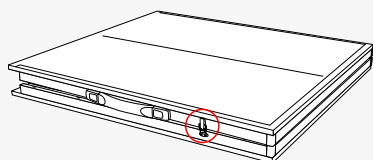

B

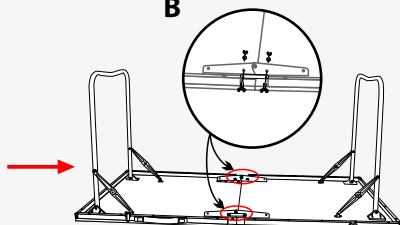

C

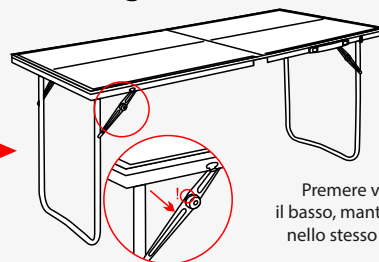

CHIUDERE

A

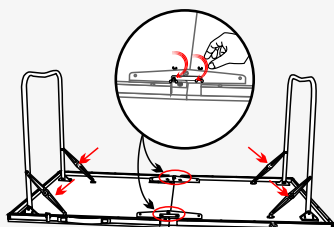

B



C

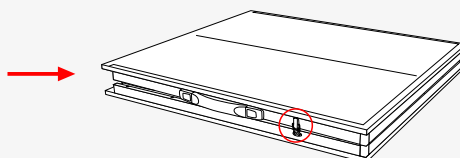

TABLE TENNIS TABLE MINI 1500 BASIC



GUARANTEE

Congratulations on your purchase of the Cougar Table tennis table. You have bought a product you will enjoy for many years. Cougar provides a 2-year guarantee on this product, when properly used. If the product does not reach you in good condition or if there are other problems, please contact your dealer or point of sale where you purchased the product.

Herzlichen Glückwunsch zum Erwerb der Cougar Table tennis table. Mit Ihrer Entscheidung haben Sie ein Produkt erworben, an dem Sie viele Jahre lang Freude haben werden. Cougar gibt eine Garantie von 2 Jahren auf dieses Produkt, bei richtiger Verwendung. Wenn Sie das Produkt nicht in einwandfreiem Zustand erhalten oder wenn sich andere Probleme ergeben, wenden Sie sich dann an den Händler oder die Verkaufsstelle, wo Sie das Produkt erworben haben.

Gefeliciteerd met uw aankoop van de Cougar Table tennis table. Met deze keuze heeft u een product gekocht waarvan u jarenlang plezier zult hebben. Cougar verstrekt op dit product - bij juist gebruik - een garantie van 2 jaar. Mocht het product u niet in goede staat bereiken of als er zich andere problemen voordoen, neem dan contact op met uw dealer of verkooppunt waar u het product heeft aangeschaft.

Félicitations pour votre achat du Cougar Table tennis table. Vous avez choisi un produit qui vous apportera du bonheur pendant des années. Sur le produit, Cougar offre une garantie de 2 ans, à condition de l'utiliser de manière adéquate. Veuillez contacter votre revendeur ou le point de vente où vous l'avez acheté si le produit n'est pas livré en bon état ou si vous constatez un autre problème.

Felicidades por la compra del Cougar Table tennis table. Al elegir nuestra marca, usted disfrutará muchos años de un producto de calidad. Cougar ofrece una garantía de 2 años el producto, siempre que se utilicen de forma adecuada. Si el producto no cumple con las especificaciones en el momento de la entrega o en caso de otros problemas, contáctese con el distribuidor o el punto de venta donde se realizó la compra.

Congratulazioni per l'acquisto della Cougar Table tennis table. Con l'acquisto dei nostri prodotti avete scelto una qualità che dura nel tempo. Il prodotto - fermo restando un idoneo utilizzo - da una garanzia Cougar di 2 anni. Qualora il prodotto non risulti conforme alle specifiche all'atto della consegna o in caso di altri inconvenienti, contattare il rivenditore o il punto vendita presso cui è avvenuto l'acquisto.



WARNING!

Manufacturer and seller expressly disclaim any and all liability for personal injury, property damage or loss, either direct, indirect or incidental, resulting from the incorrect attachment, improper use, inadequate maintenance, or neglect of this product.

BY PRAGMA



TABLE TENNIS TABLE MINI 1500 BASIC

Pragma

multi-brands for toys and garden

A Pragma Brand

Cougar is one of our brands with fun table games of great quality that provides hours of fun!

Pragma

Kruisboog 40
3905 TG Veenendaal
Netherlands
T: +31 (0)318 - 57 88 00
info@pragma-trading.com
www.pragma-trading.com

BY PRAGMA